

1.

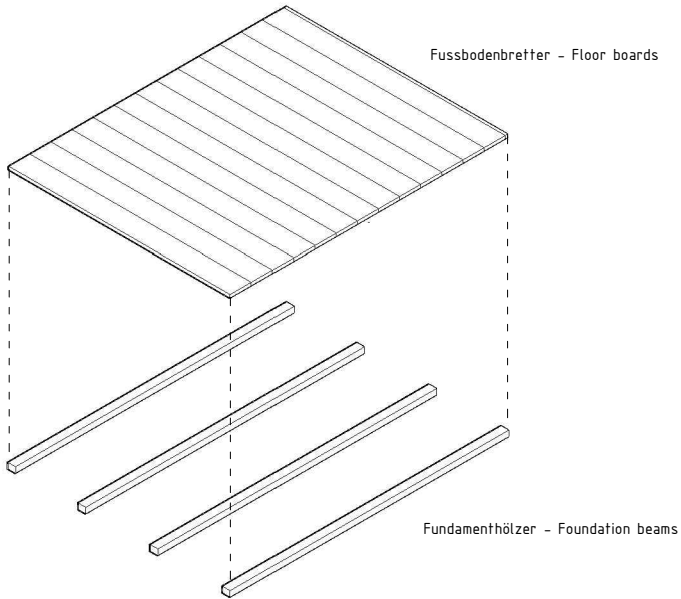

2.

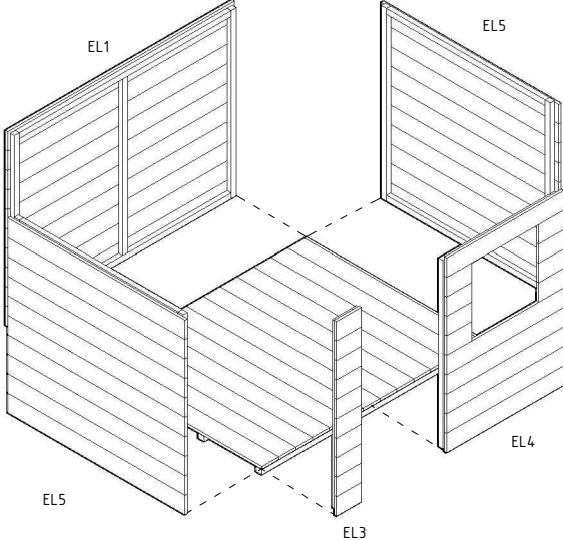

3.

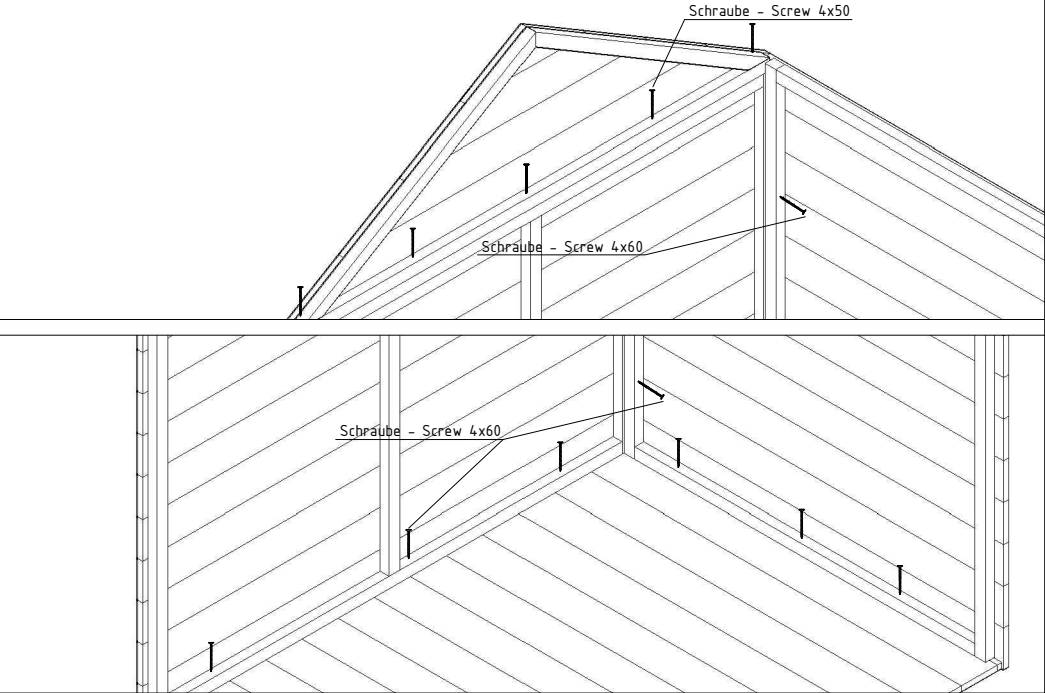
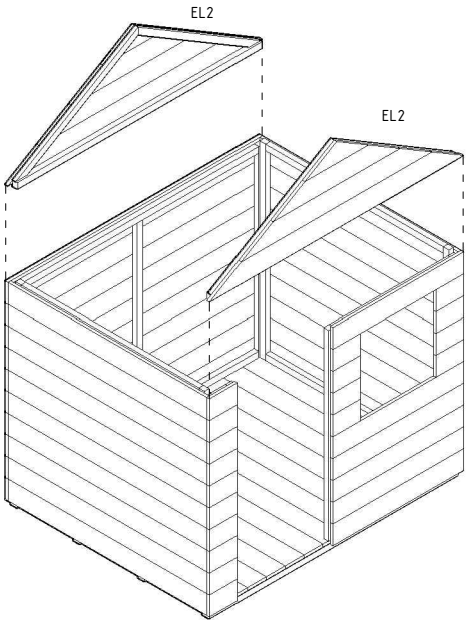

4.

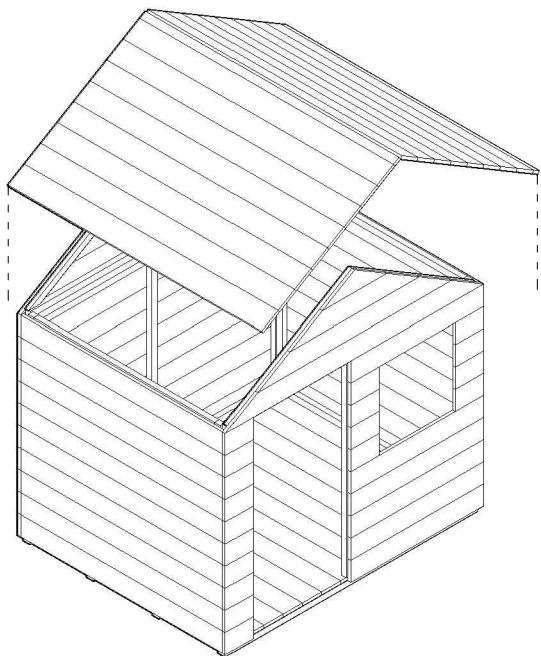

5.

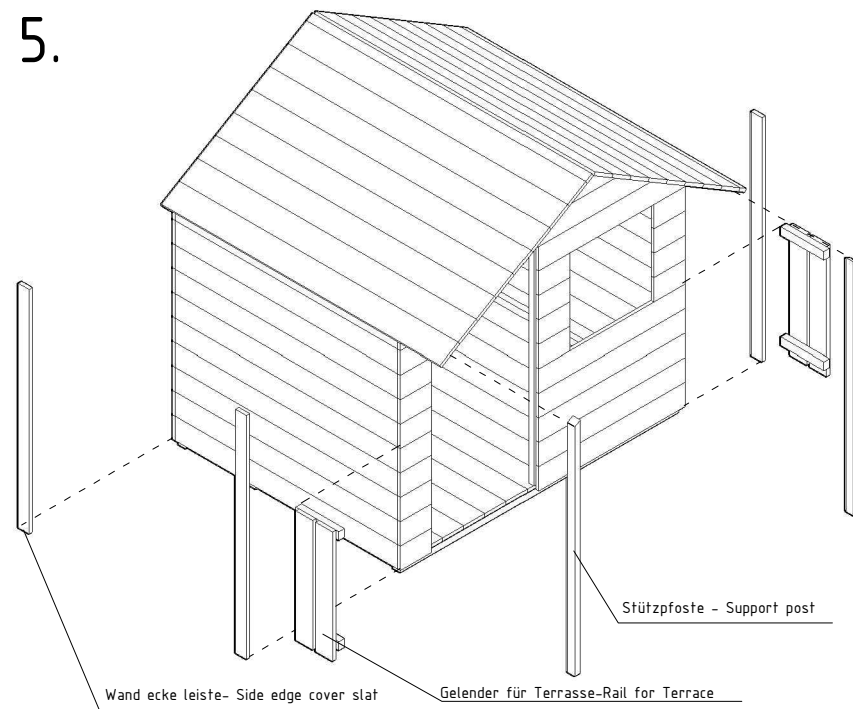

6.

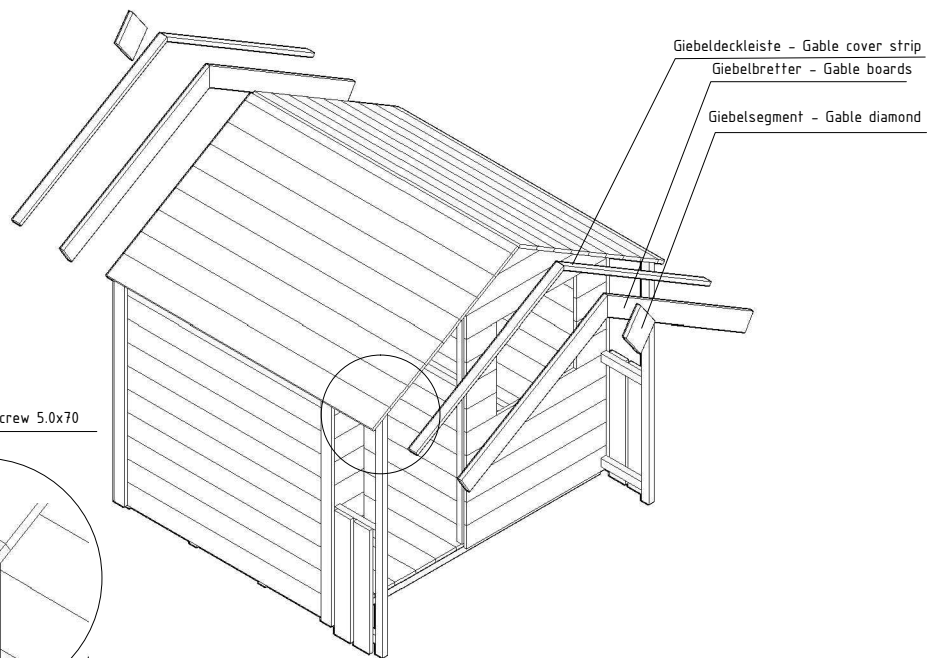

7.

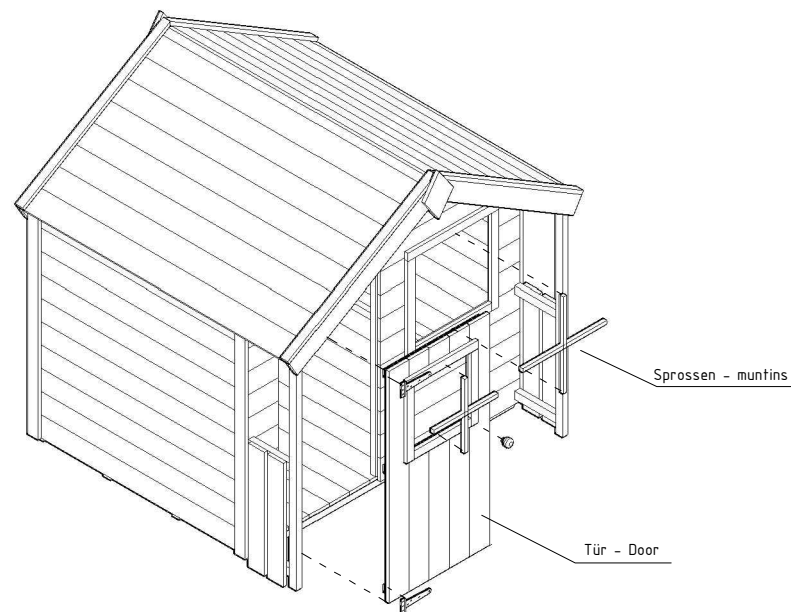

Wand / Wall 1

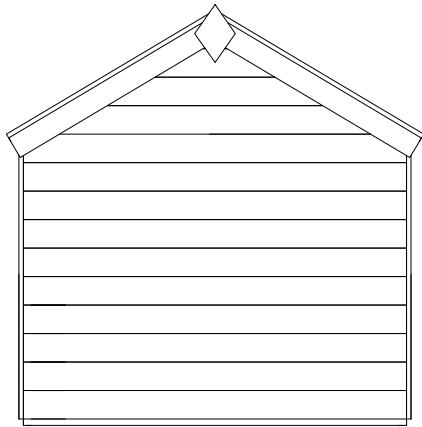

Wand / Wall 2

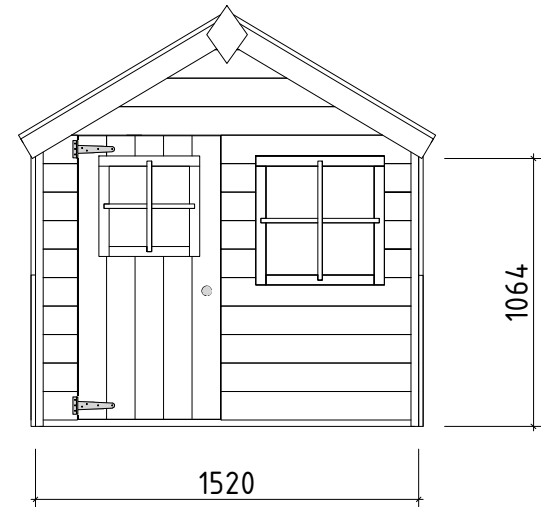

Wand / Wall A

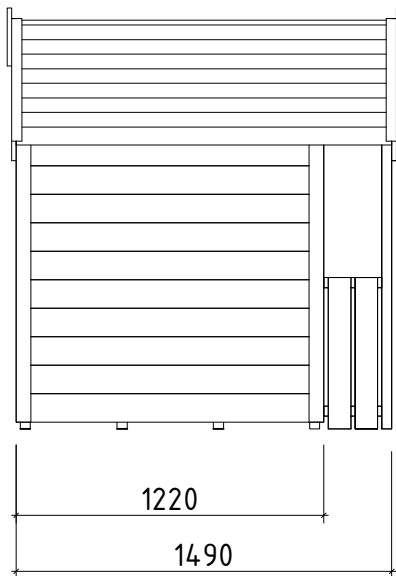

Wand / Wall B

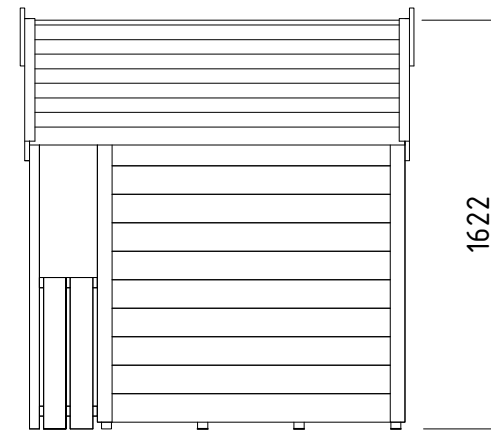

Name	Sneeuwitje 152x122_16		
Zeichnung/Drawing	WAND/WALL		
Profil/Profile	1.6x11.3	Datum/Date	15.12.2016

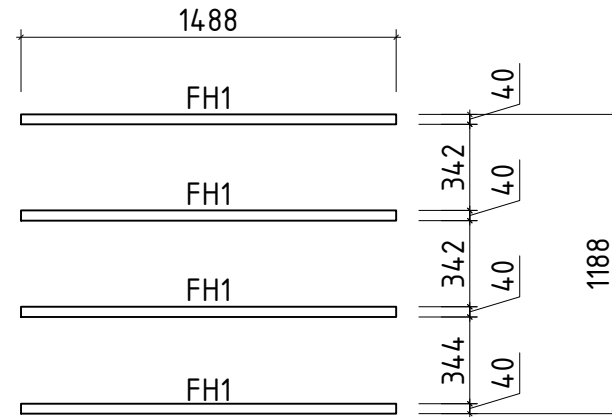
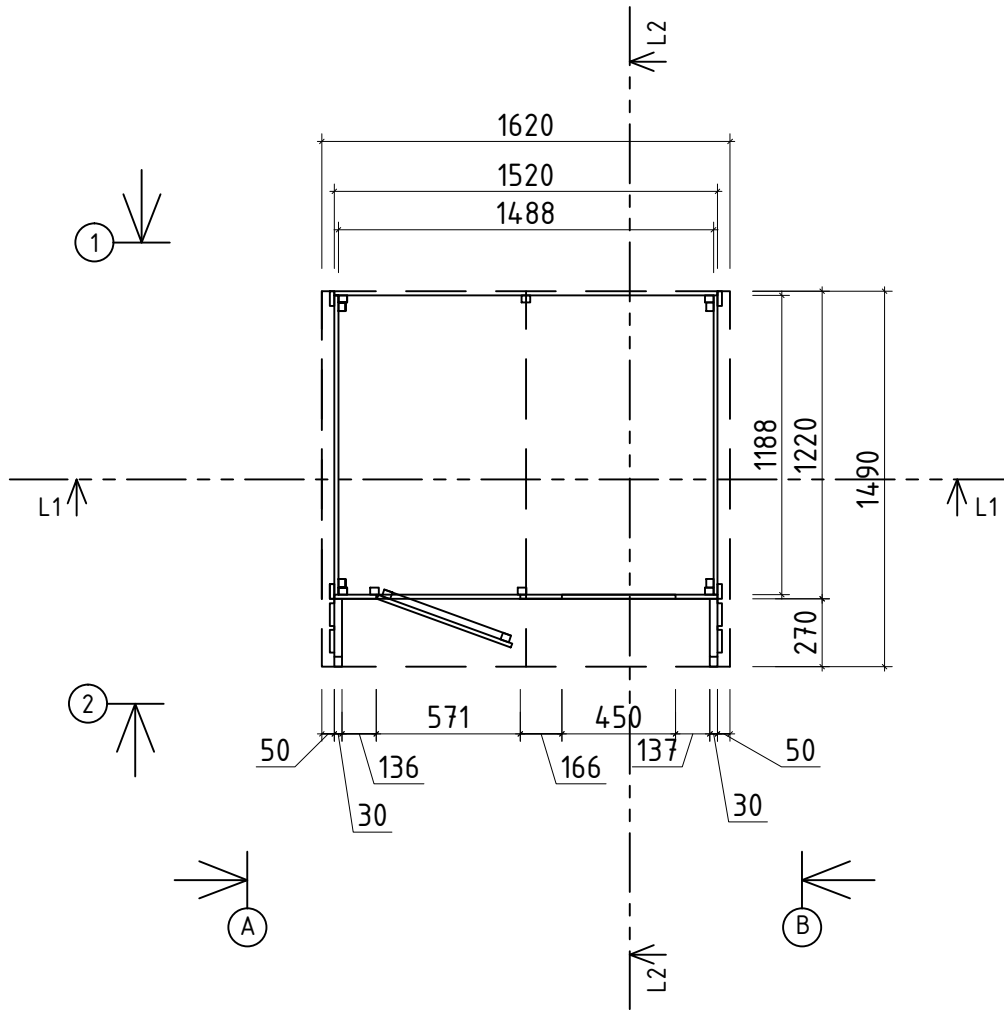

Name	Sneeuwitje 152x122_16	
Zeichnung/Drawing	Grundplan/Plan, Lagerholzplan/Foundation beams	
Profil/Profile	1.6x11.3	Datum/Date 15.12.2016

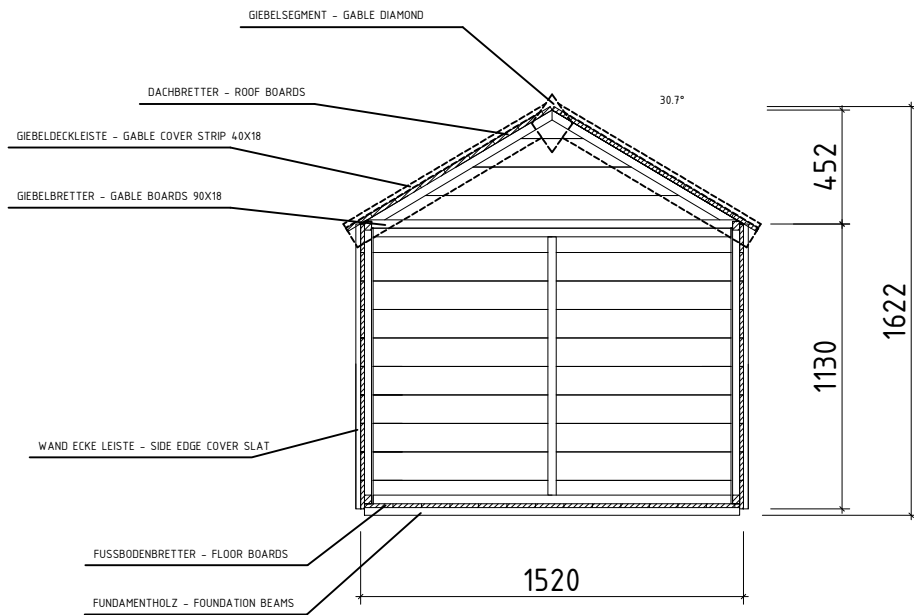

L1-L1

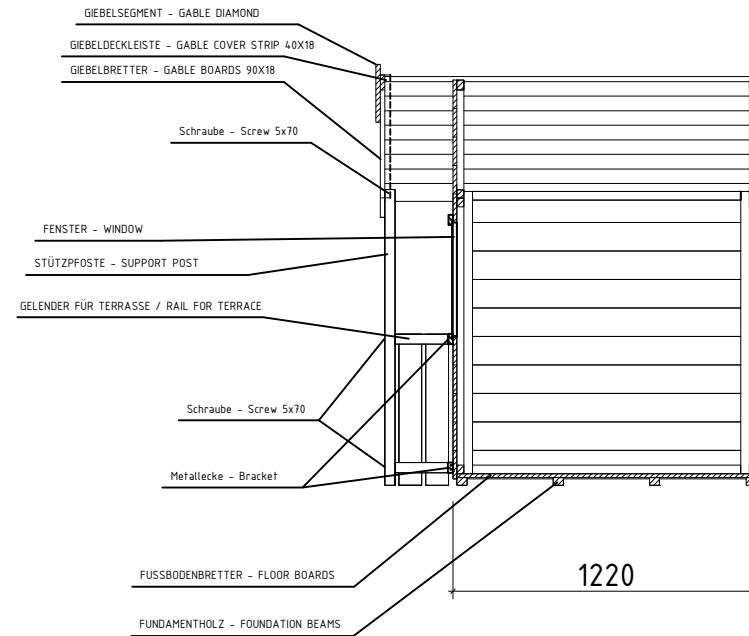

L2-L2

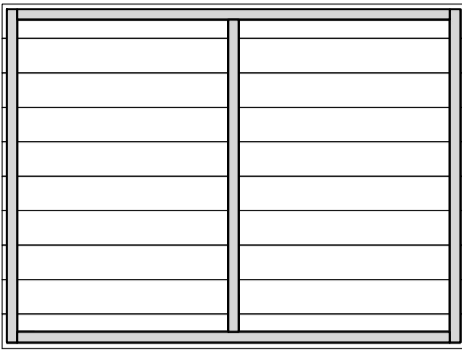
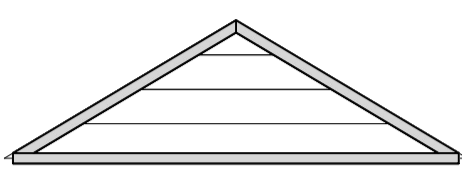
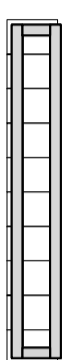
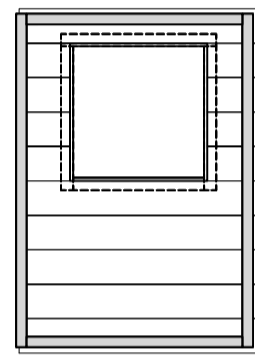
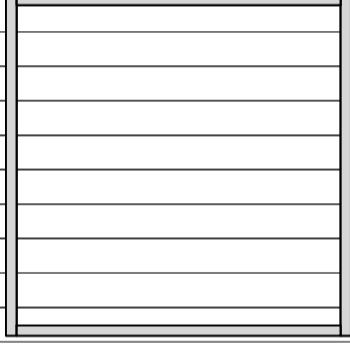
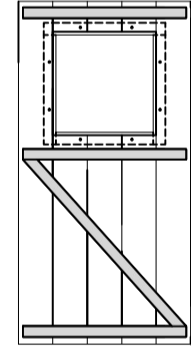
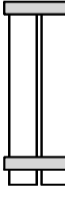
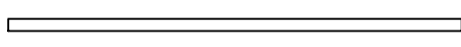

Name	Sneeuwitje 152x122_16		
Zeichnung/Drawing	Schnitt/Section		
Profil/Profile	1.6x11.3	Datum/Date	15.12.2016

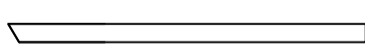
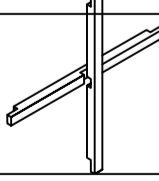
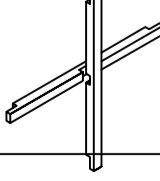
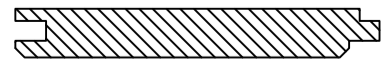
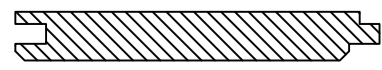
Pos	Teileliste/Specification Sneeuwitje 152x122_16		Stck. Pcs.	Profil Profile (mm)	Länge Length (mm)
EL1 Wand / Wall 1			1	1520x1130	
EL2 Wand / Wall 1 Wand / Wall 2			2	1520x469	
EL3 Wand / Wall 2			1	176x1130	
EL4 Wand / Wall 2 mit Fenster / with Window			1	793x1130	
EL5 Wand / Wall 3 Wand / Wall 4			2	1188x1140	
EL6 Tür / Door 565x1125			1	565x1125	
EL7 Gelender für Terrasse / Rail for Terrace			2	230x600	
FH1	FUNDAMENTHOLZ (imprägniert) - FOUNDATION BEAM (impregnated) 		4	30x40	1488
LE4	Wand ecke leiste - Side edge cover slat 		4	58x18	1130
LE2	30.7° 		2	40x30	1174
Sprossen - Muntins Fenster - Window			2+2	18x18	470
Sprossen - Muntins Tür Fenster - Door Window			2+2	18x18	359
DACHBRETTER - ROOF BOARDS			18	113x16	1490
FUSSBODENBRETTER - FLOOR BOARDS			14	113x16	1185
Kood	Sneeuwitje 152x122_16	Materjal	File	Sneeuwitje 152x122_16 KL	ENTwurf 1/2

